

CUBO

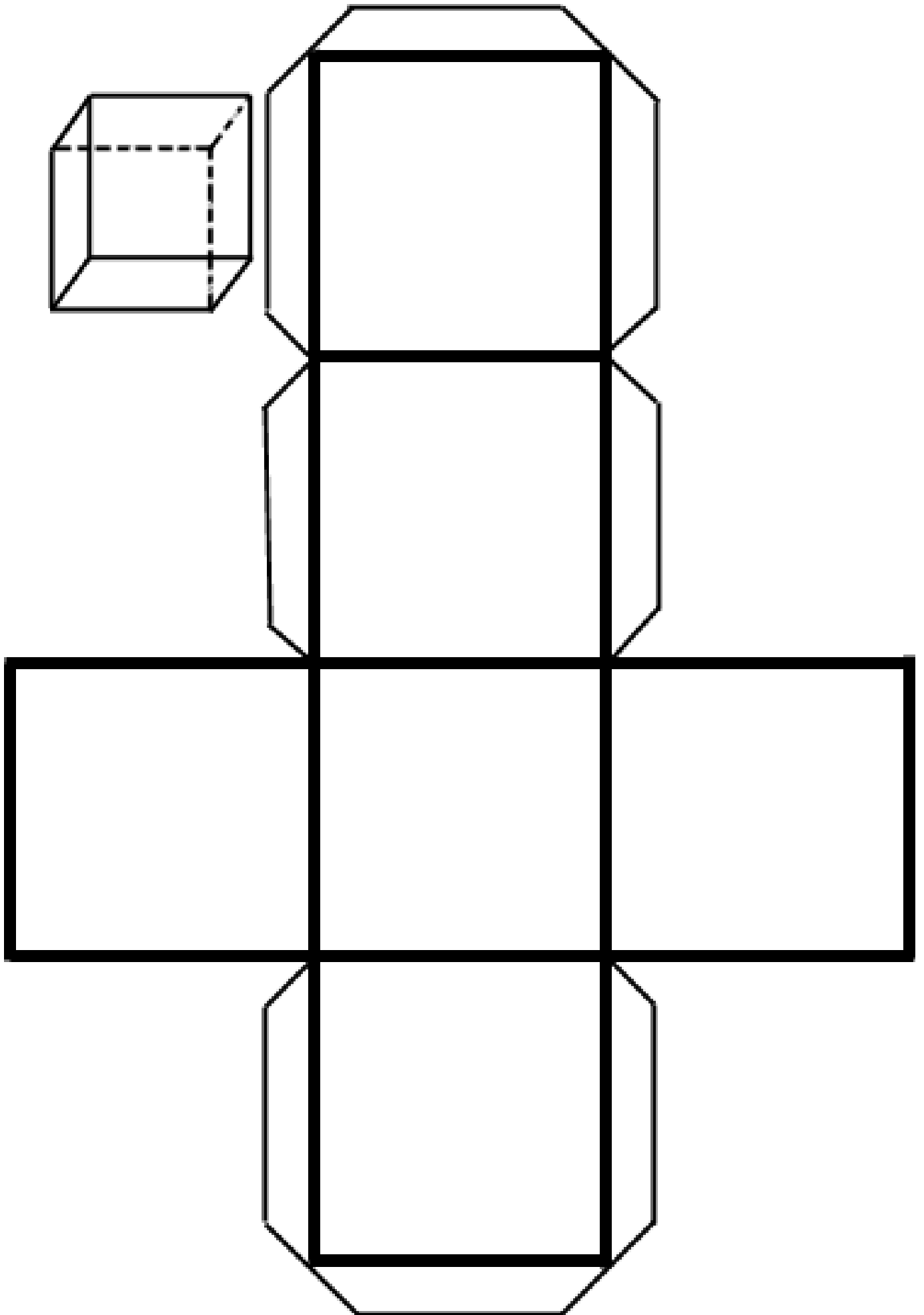

TETRAEDRO

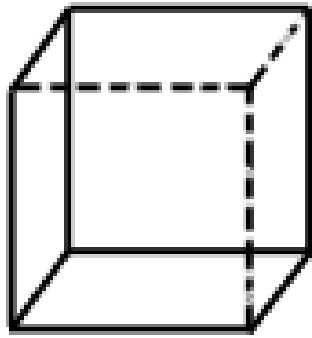
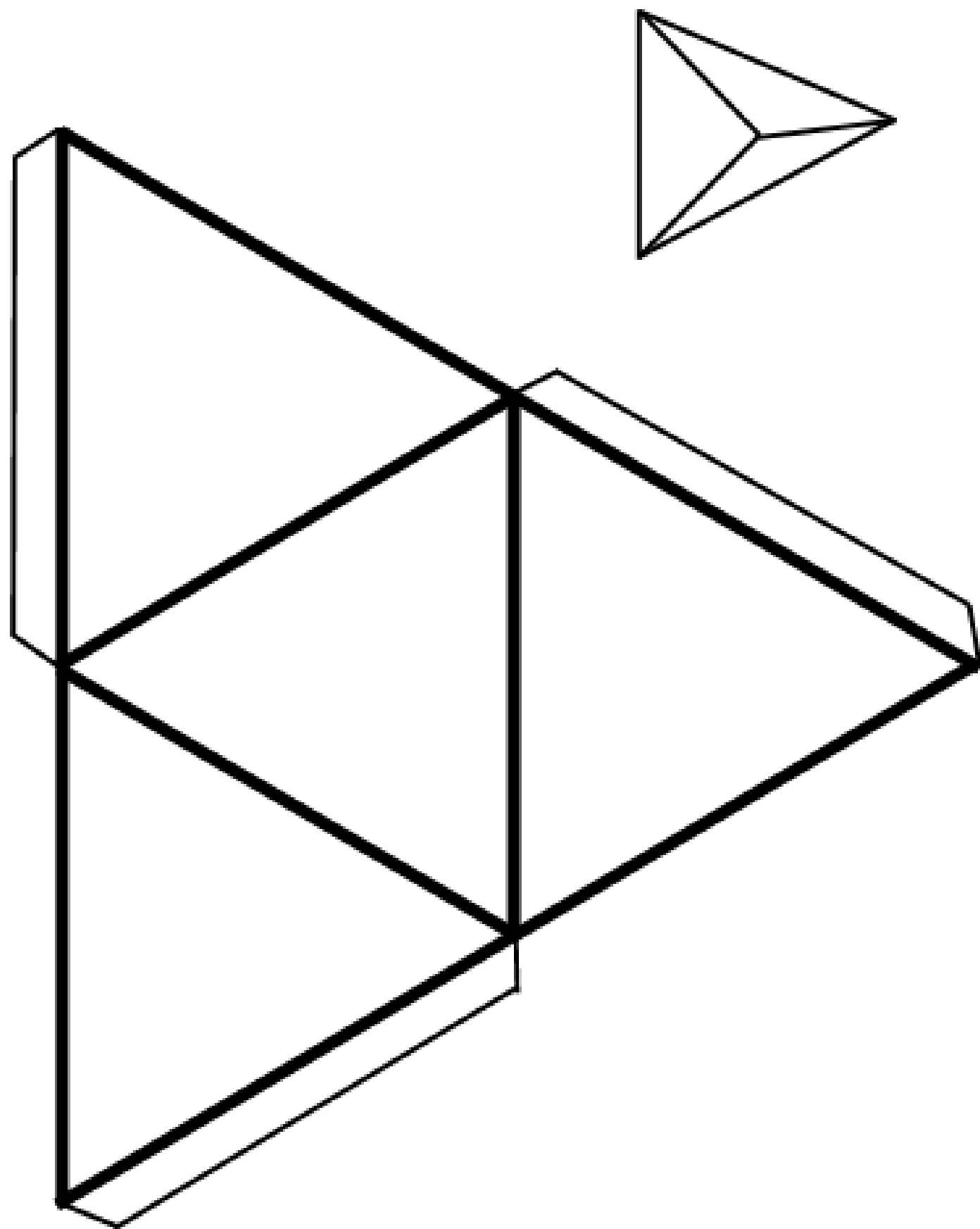

DODECAEDRO

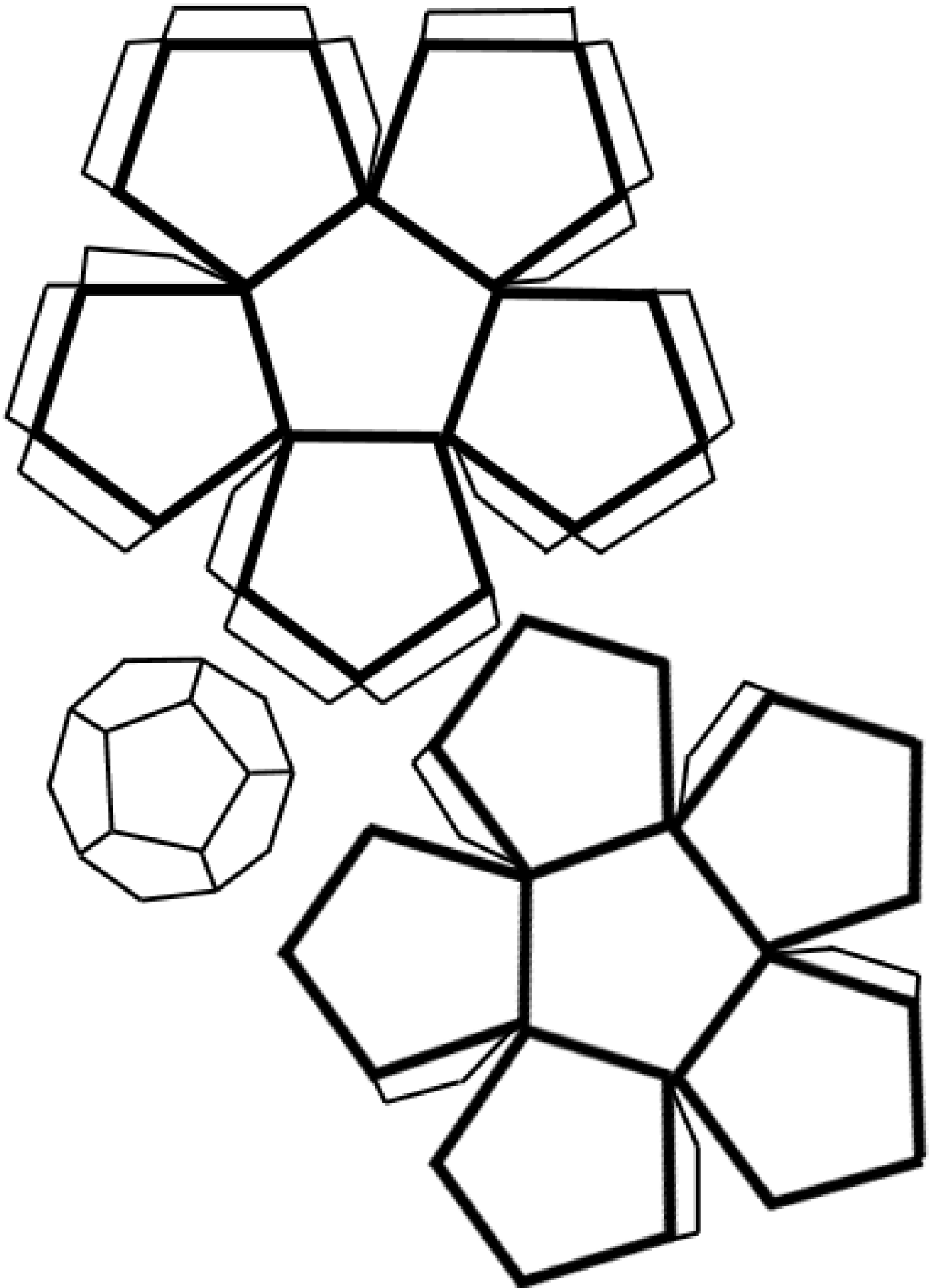

ICOSAEDRO

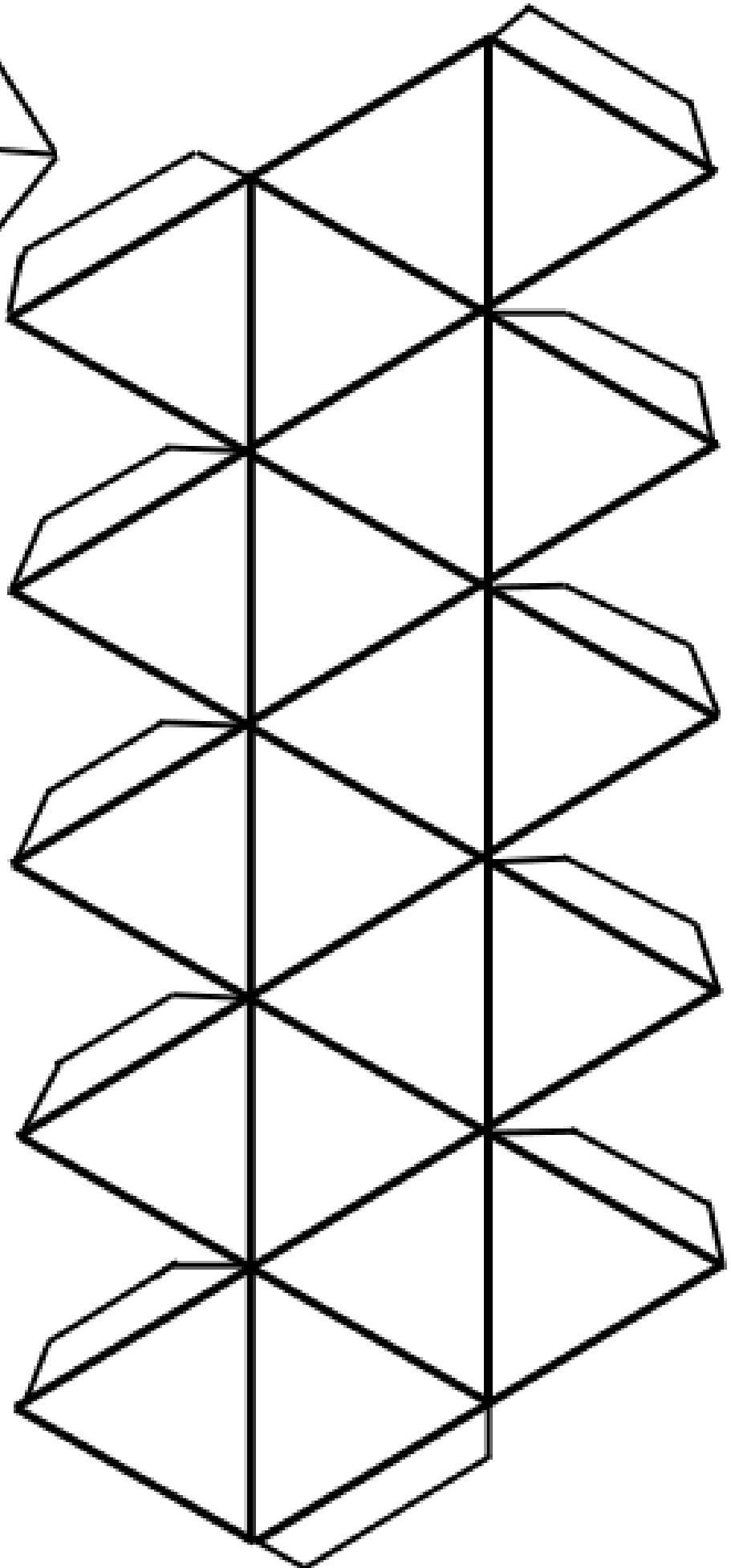
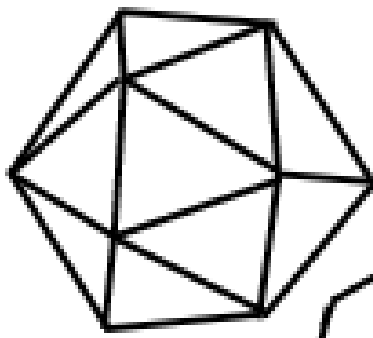

OCTAEDRO

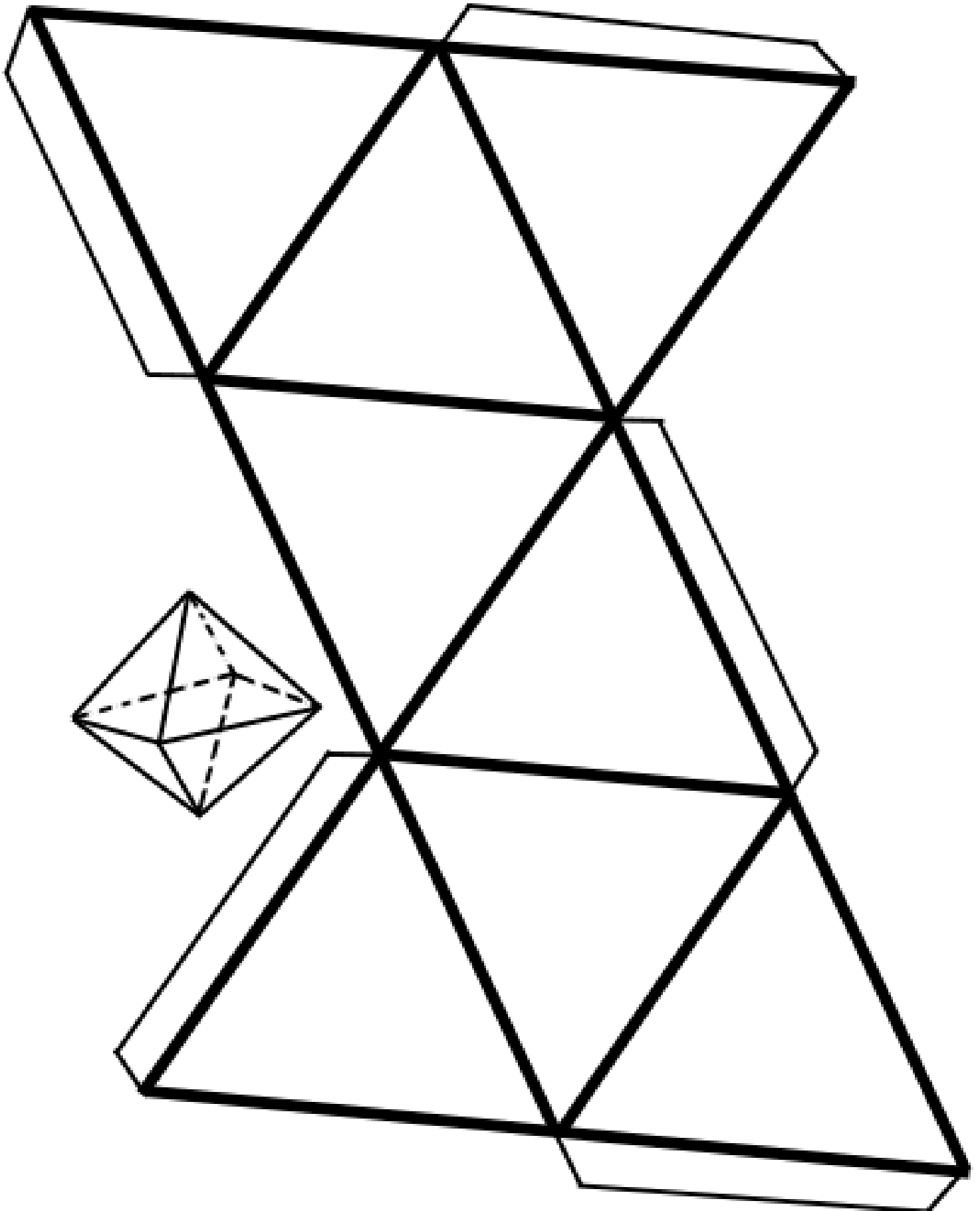

PIRÁMIDE TRIANGULAR

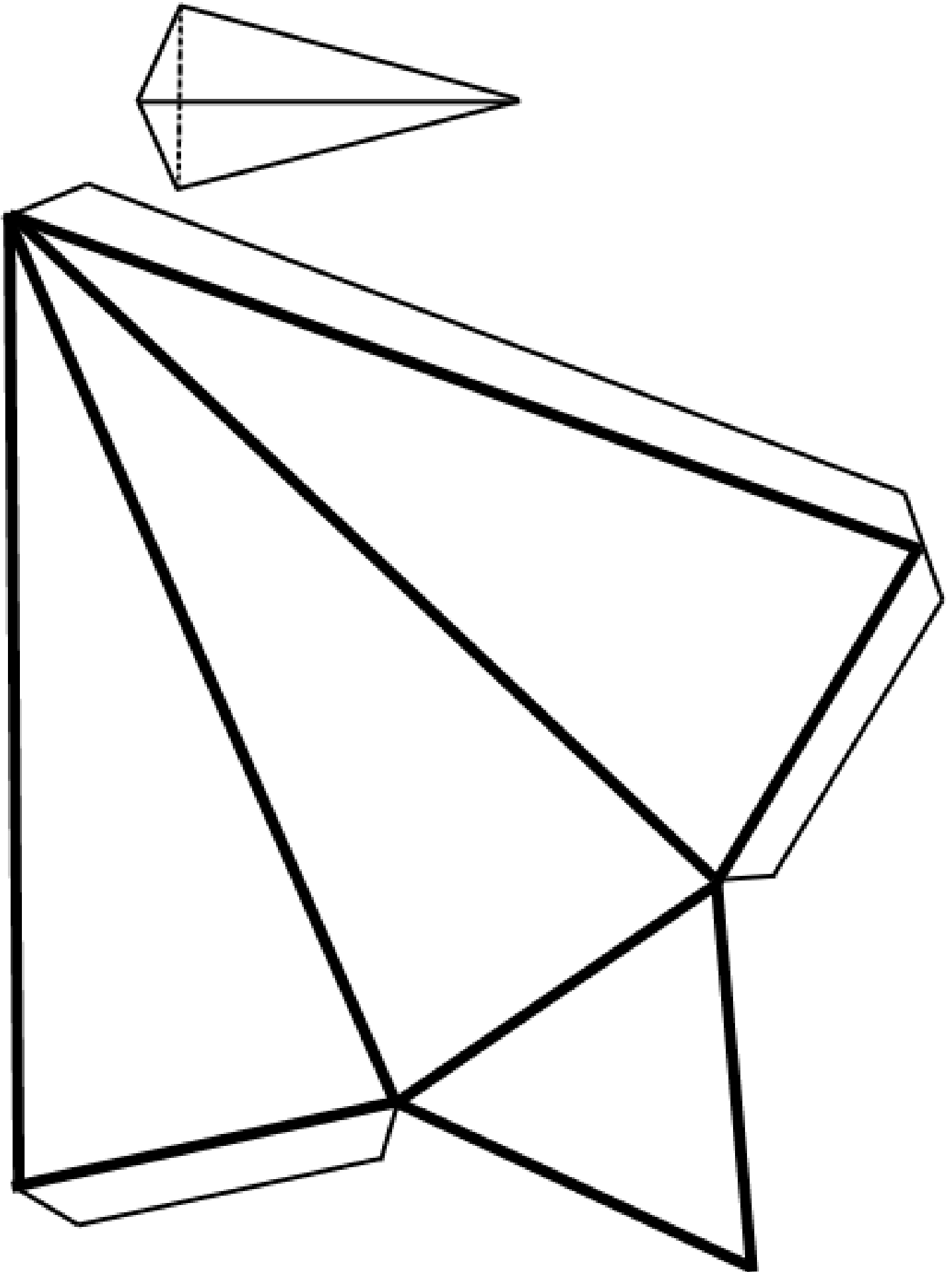

PIRÁMIDE CUADRANGULAR

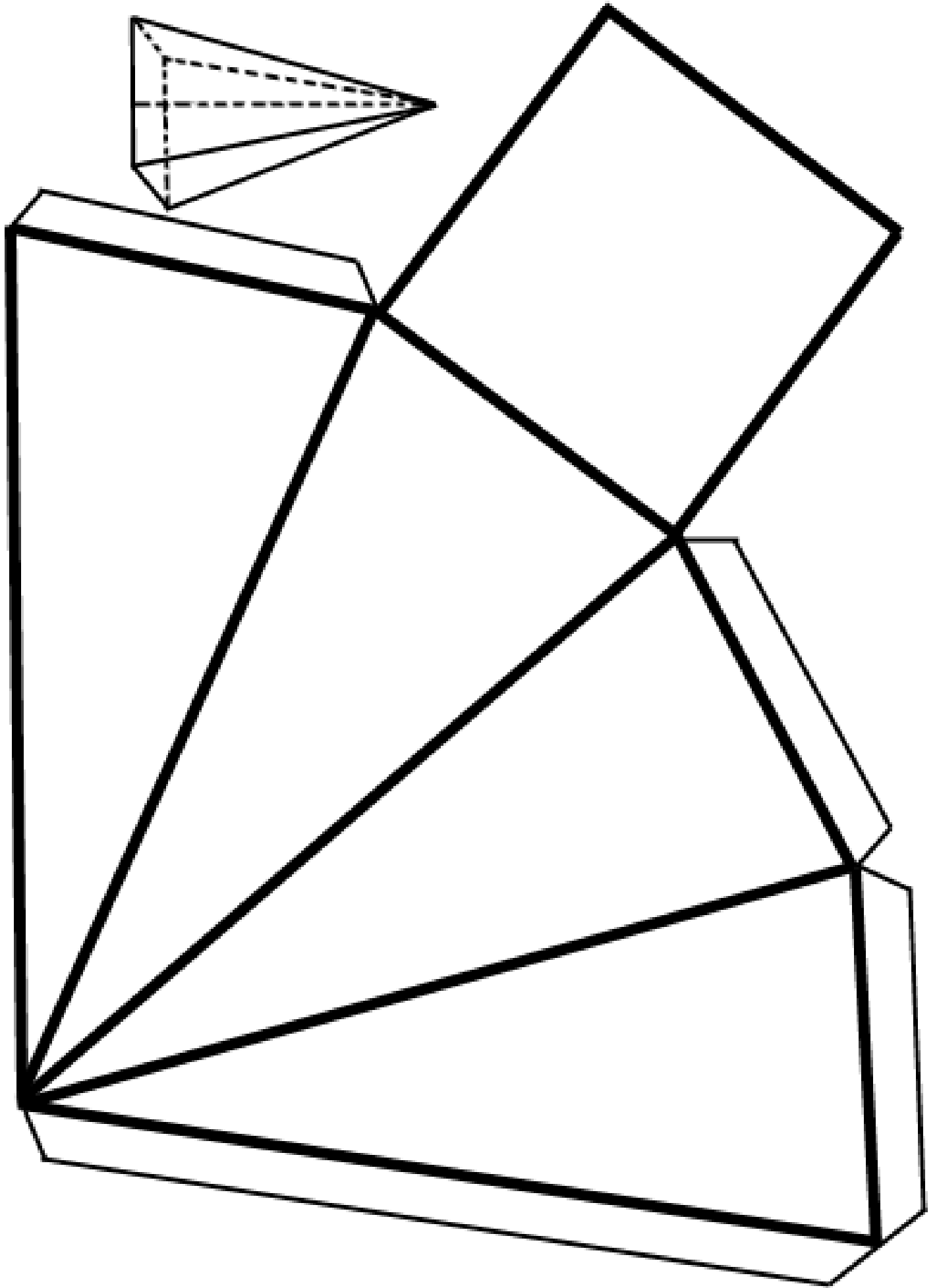

PIRÁMIDE PENTAGONAL

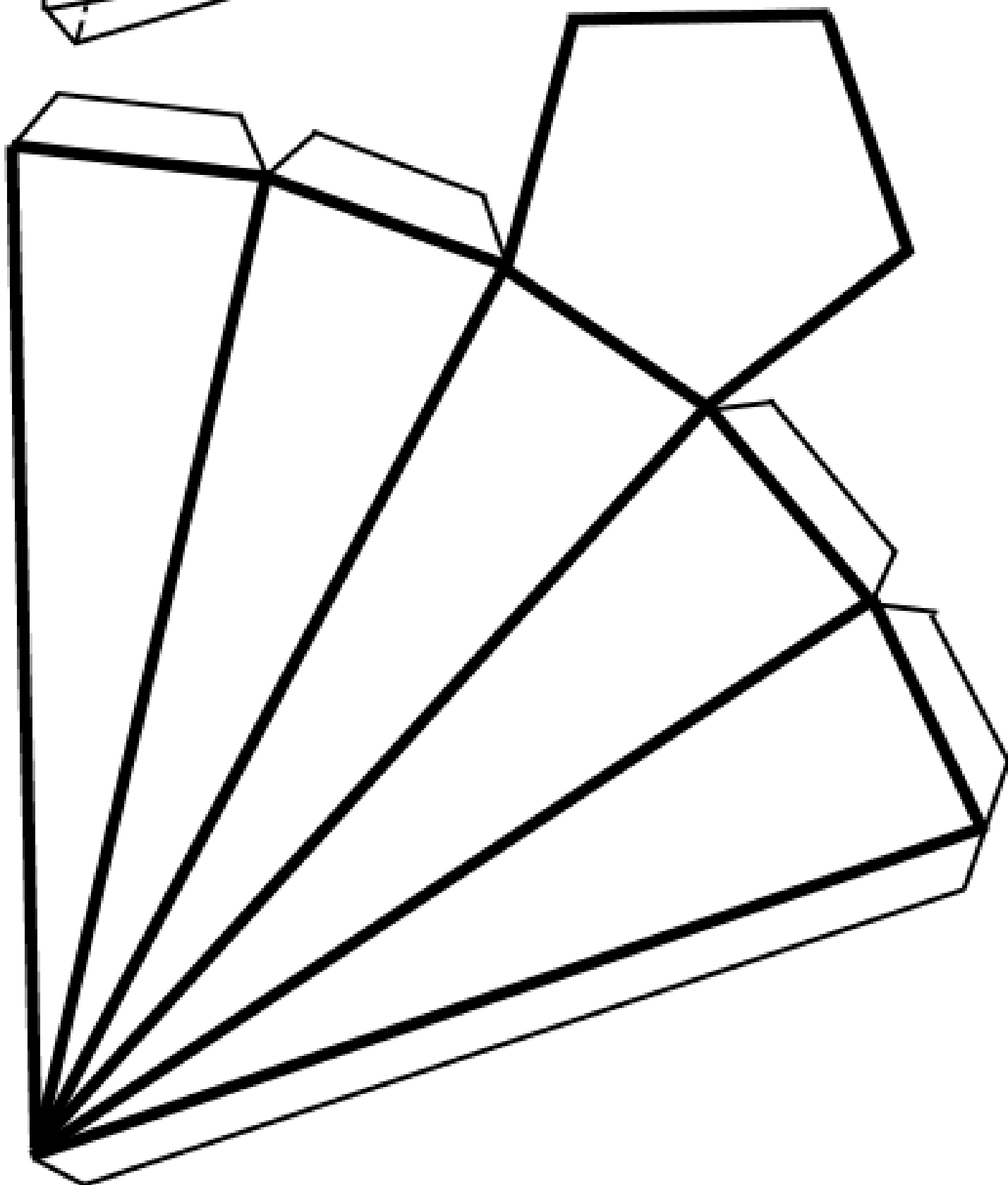
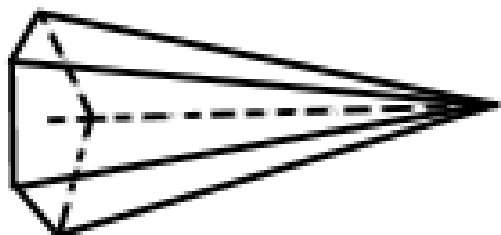

PIRÁMIDE HEXAGONAL

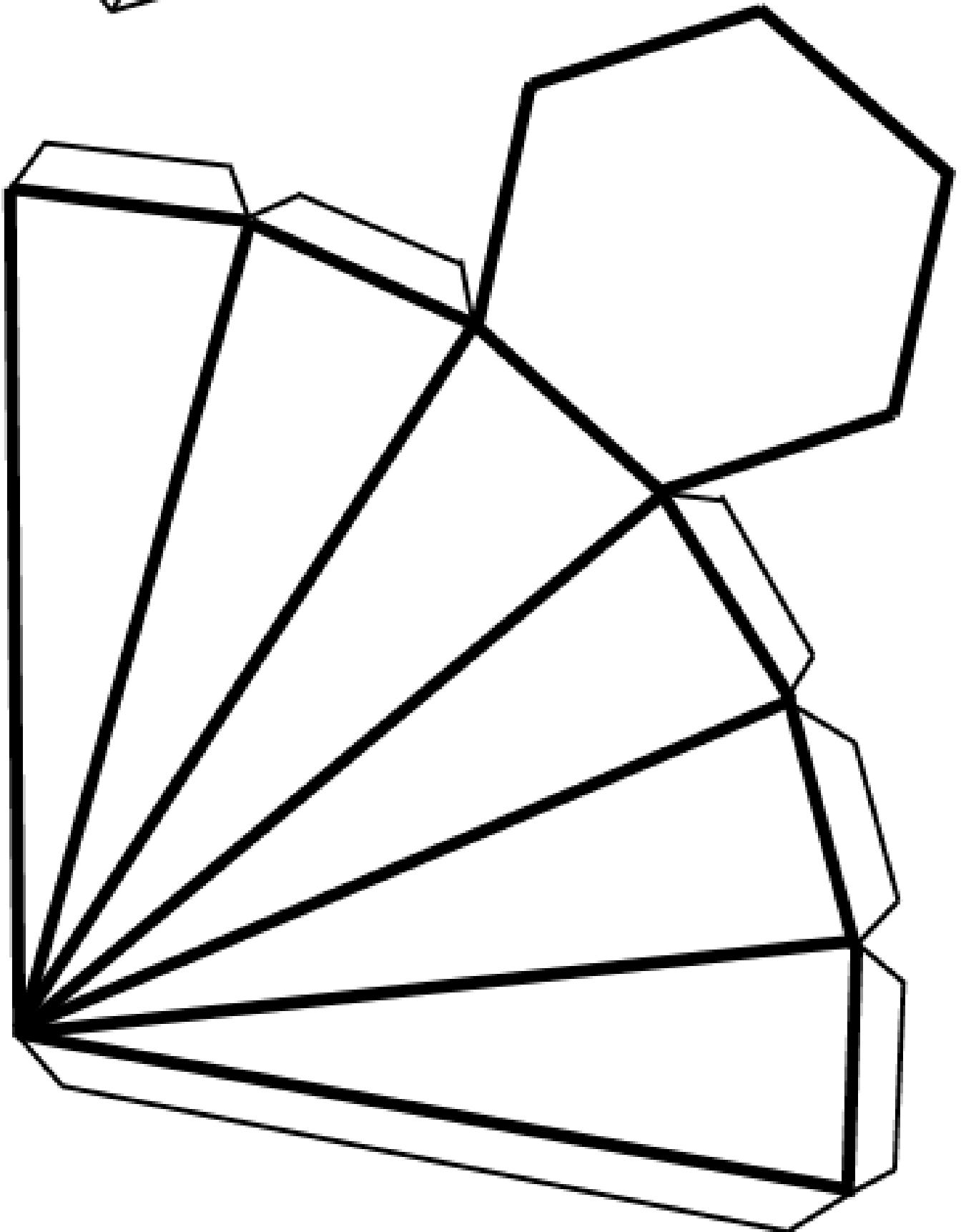
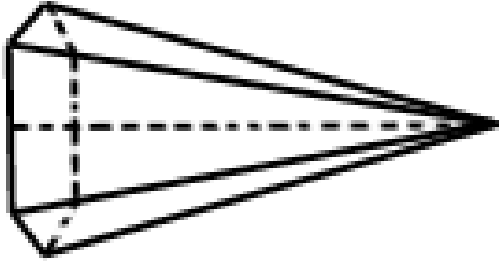

PIRÁMIDE OCTOGONAL

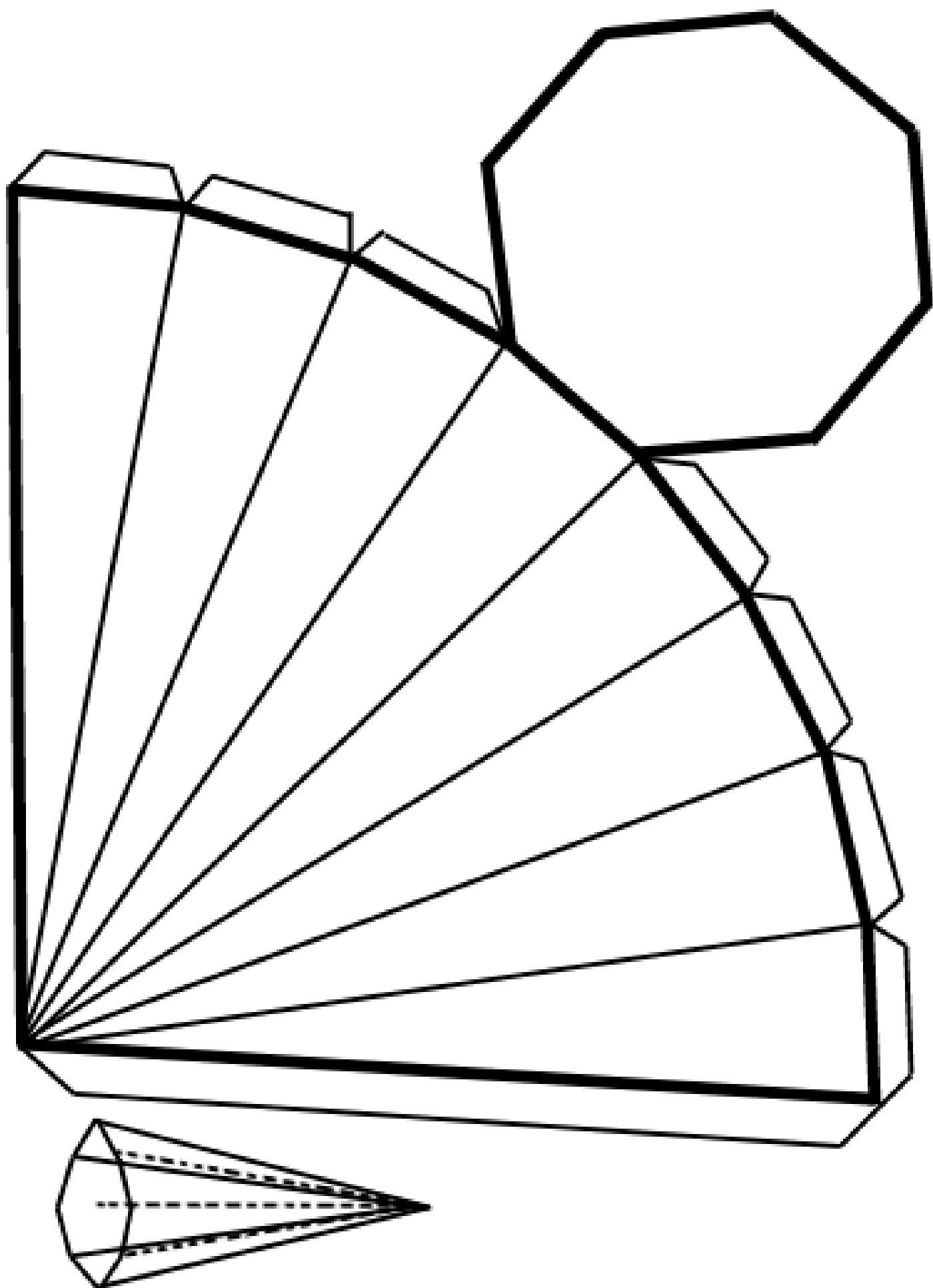

PRISMA TRIANGULAR

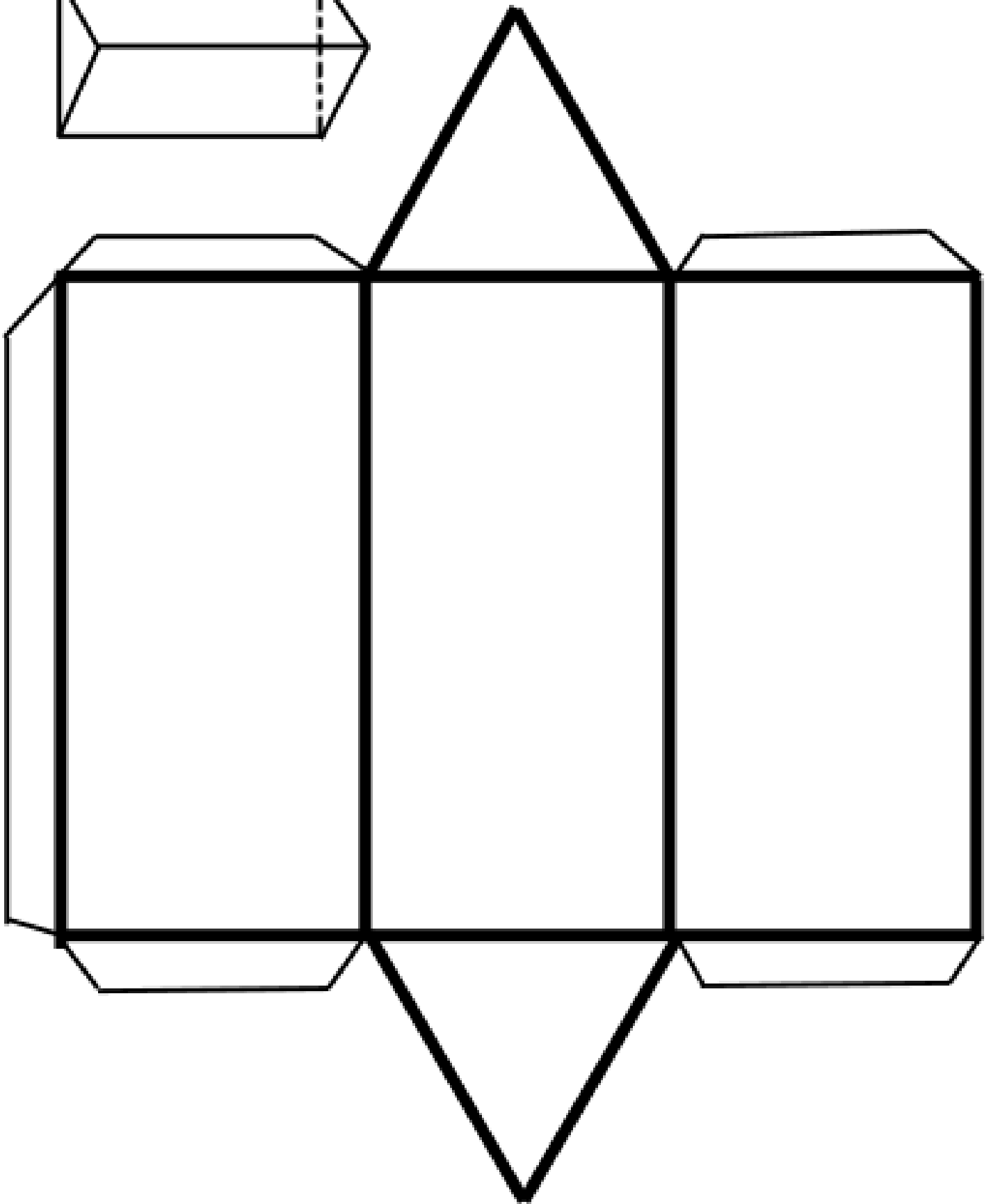

PRISMA CUADRANGULAR

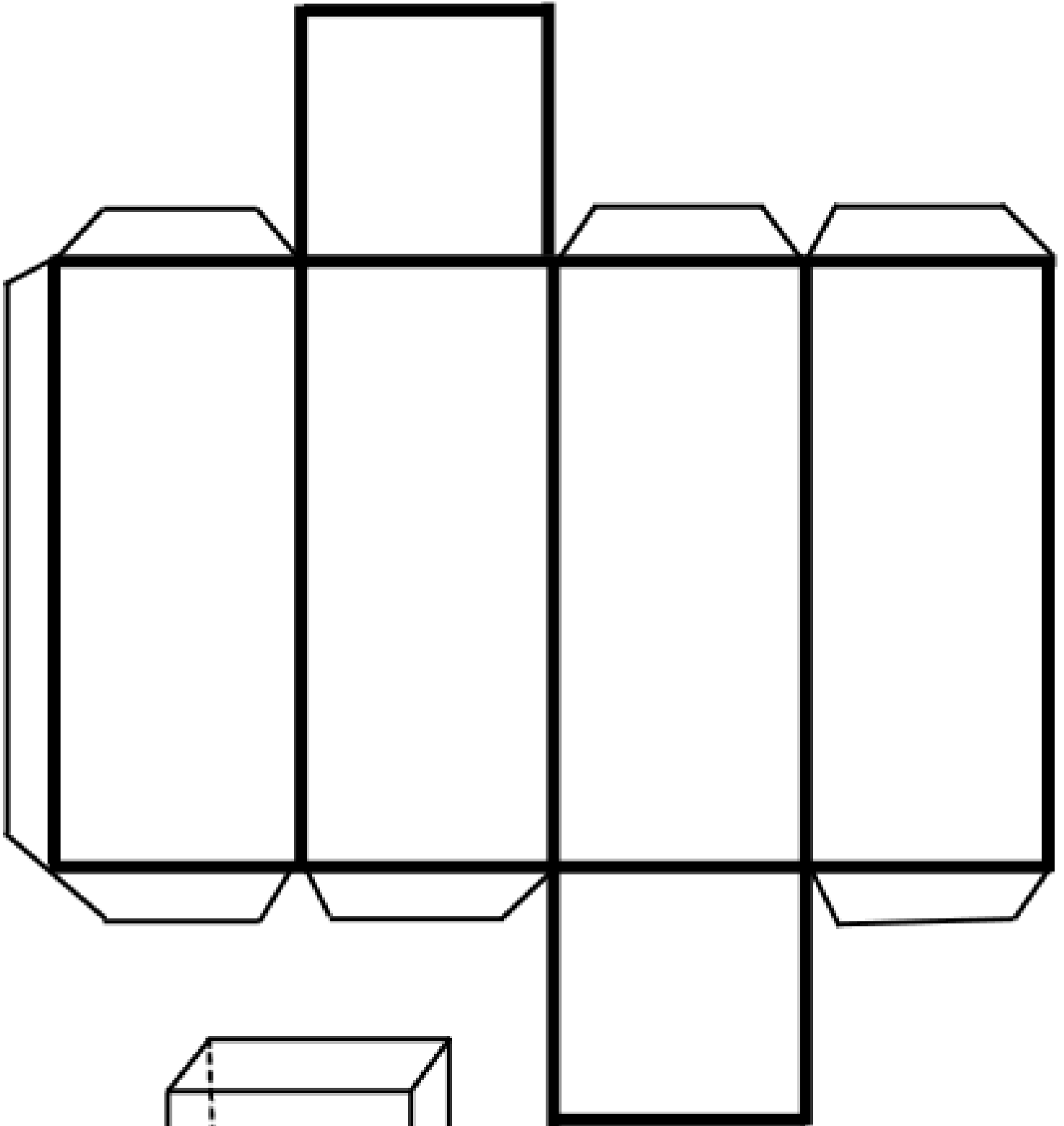

PRISMA PENTAGONAL

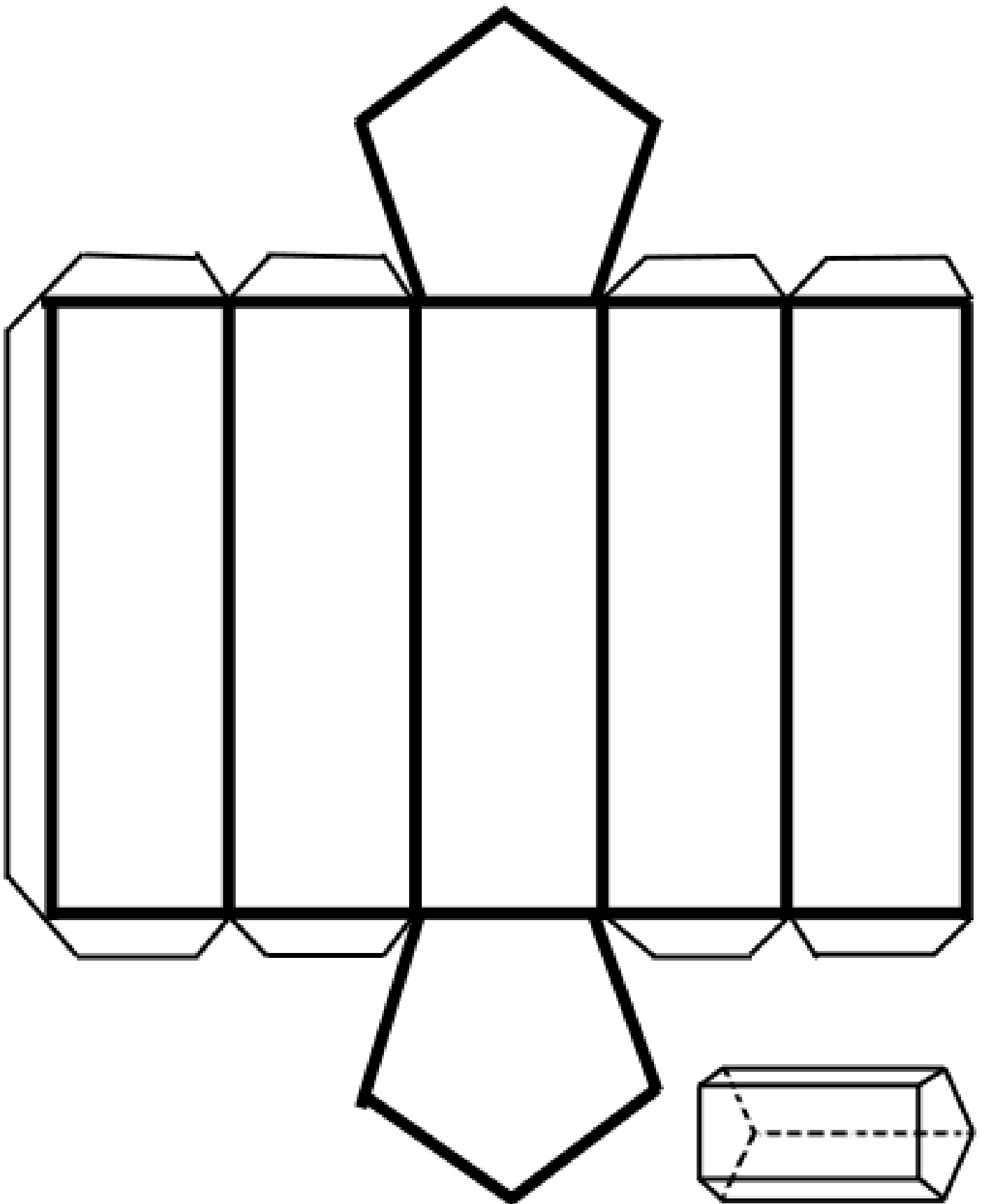

PRISMA HEXAGONAL

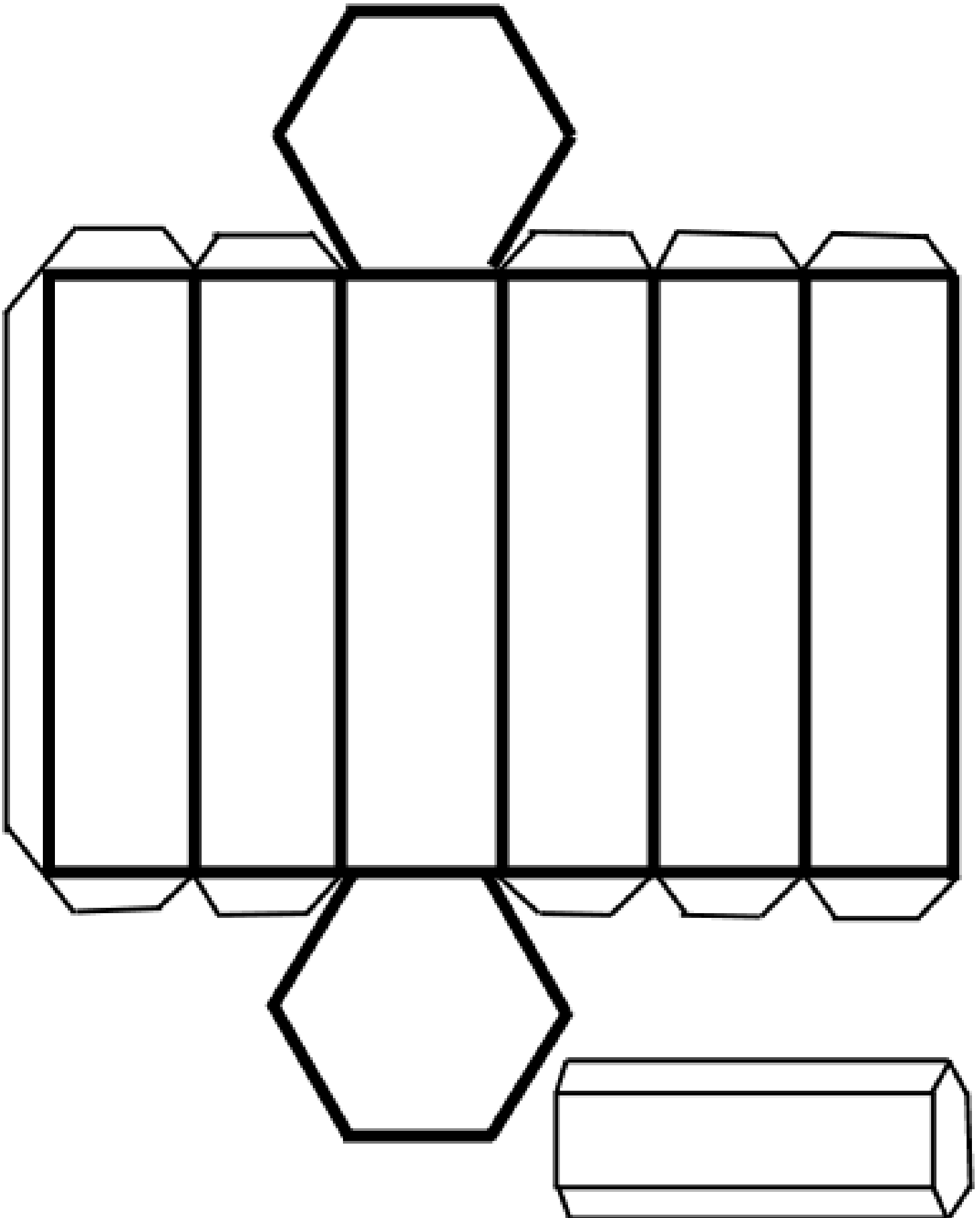

CILINDRO

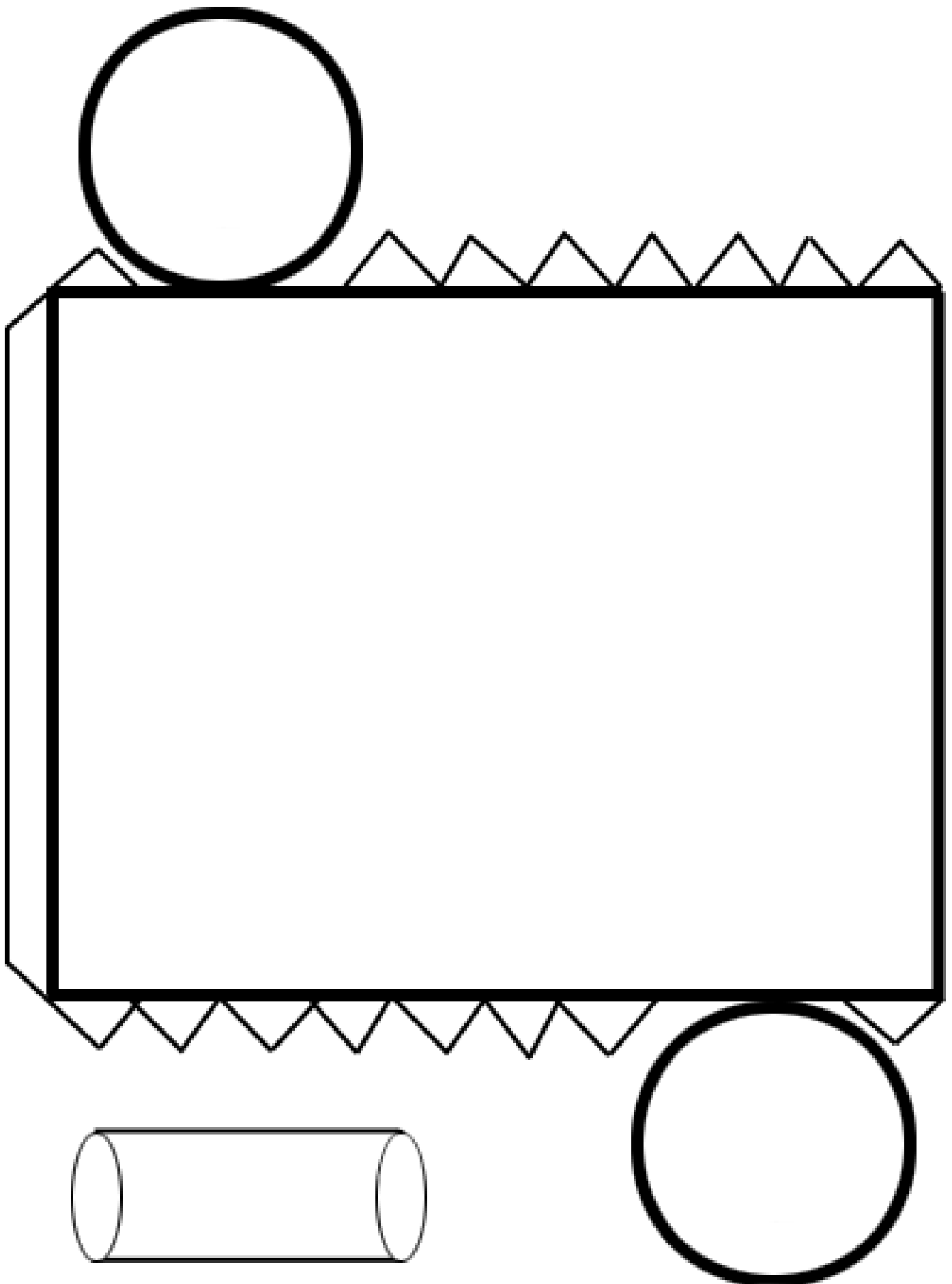

CONO

